

# USER MANUAL



Thank you for choosing Better Bathrooms.  
Please read this manual before installing your product  
and keep for future reference.

**better**   
**bathrooms**

## General Instruction of Bath with Metal Feet



- **Two-person assembly**
- **Tools required**
- **We always recommend using professional tradespeople to install your product**

V2\_28.09.22

# Congratulations on your purchase

*And welcome to our growing gang of savvy shoppers*

We're on a mission to bring you extraordinary bathroom products, for less. From modern to traditional style ceramics, plus the gorgeous fixtures, fittings and furniture to match. So, you can fall in love with your space every single day.

As one of the UK's largest independent bathroom stores, we've received countless awards; including the National Business Awards UK, the Digital Entrepreneur Awards and being placed on The Sunday Times Fast Track 100.

We hope your new product goes above and beyond your expectations. However, should any problems occur, please:

- log in to your account and contact our customer services team via your self-serve portal – [betterbathrooms.com/CustomerAccount/Login](https://betterbathrooms.com/CustomerAccount/Login)
- contact us via [betterbathrooms.com/content/contact-us](https://betterbathrooms.com/content/contact-us)

## Important information

- Please read these instructions thoroughly and retain for future reference
- Always check for pipes and cables before drilling
- Freestanding bath is not designed to take weight on the rim, Do not sit or stand on the bath rim.
- Bath feet and waste are supplied separately.

## Receive Your Bath

### **Unpack and check for damage.**

After receiving your bath, please unpack and remove all packaging, checking for damage, damage reported after painting will not be covered.







Repack the bath if it is not being immediately installed.

Metal bars required for feet installation are attached to the underside of the bath, except for Athena baths which are supplied with the bath feet.

### **Protect your bath.**

Before commencing installation, ensure the bath is completely protected, leave covering in place until the bathroom is complete. Scratches and damage incurred during installation are not covered by the warranty.

## Parts

No.	Part	Qty			Pic
		Option A	Option B	Option C	
A	Bar	4	3	2	
B	Screw	4	4	4	
C	Nut	12	10	8	
D	Washer	12	10	8	
E	Fastener washer	4	4	4	
F	Adjustable feet	4	4	4	

## Tools required



Adjustable Wrench

## Installation

### Step 1

- ① Ensure the bath is on a soft surface to protect against scratches.
- ② Place the bars onto the bath, along with the washers and nuts as shown below, do not tighten at this stage to allow for adjustment, taking care not to damage the bath surface.

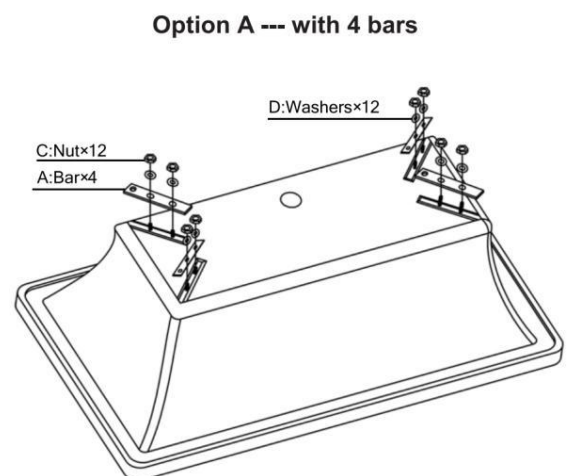
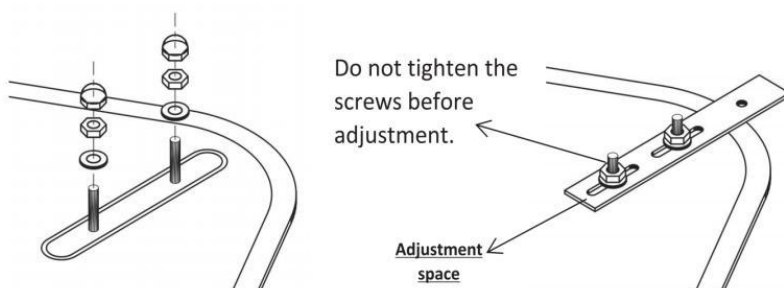

### Option B --- with 3 bars

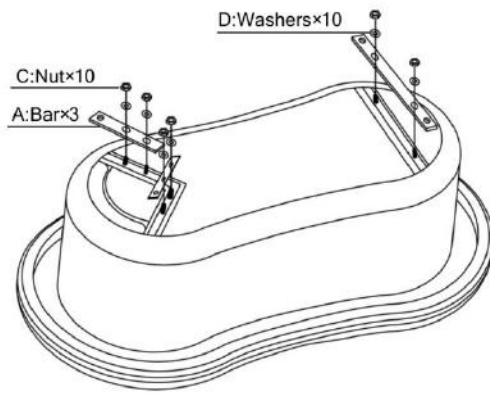

### Option C --- with 2 bars

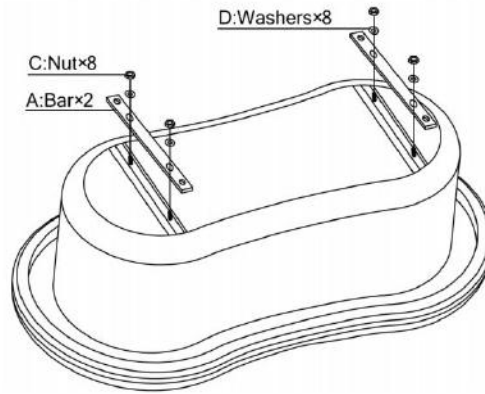

## Step 2

- ① Position the feet onto the bars and secure using the nuts and bolts provided.
- ② Adjust the position of the feet to align with the bath.
- ③ Tighten all of the nuts so that the feet are secured to the bar and the bars are secured to the bath.

### Option A --- with 4 bars

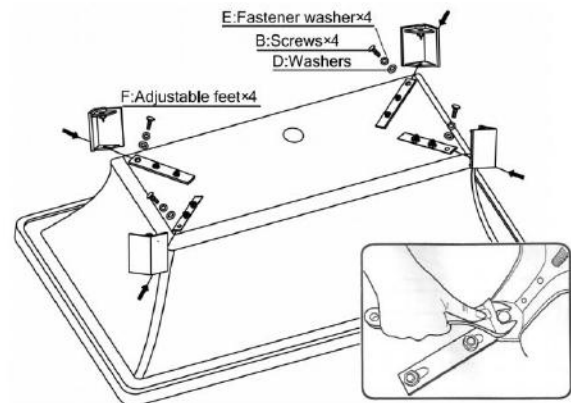
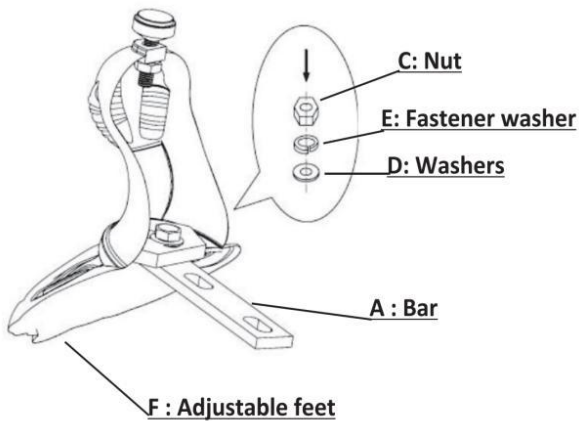

### Option B --- with 3 bars

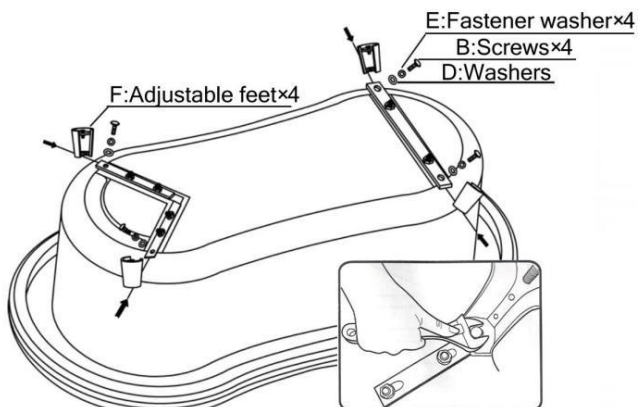

### Option C --- with 2 bars

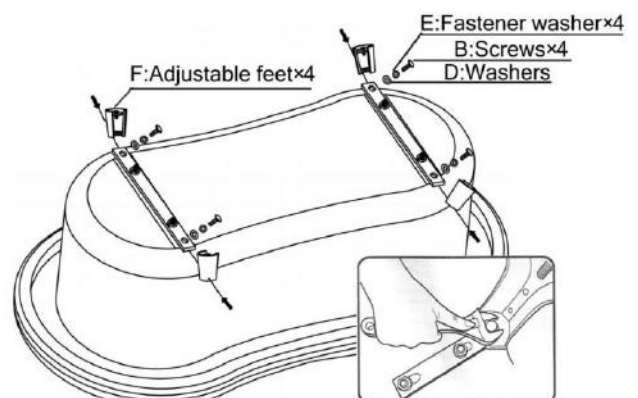

## Troubleshooting

- Movement in the feet after assembly

Please check the feet are assembled properly, make sure fastener washers and washers are placed correctly.

## Maintenance & Cleaning

- Marks on the surface of the bath, should be cleaned using a soft damp cloth, for more stubborn marks, toothpaste can be applied and then rinsed thoroughly.
- No harsh cleaning chemicals or abrasive materials can be used on any surface.
- If using coloured oils/creams, carry out a test on small area prior to use to ensure that these will not cause staining.
- Never pour coloured oils/creams directly into an empty bath, always apply them into the bath water.

## ! Warning

Pay attention to below points if the bath is designed with tap deck.

- ① The tap holes are not pre-drilled on the deck, drill holes according to your need.
- ② Check and silicone the tap holes to make sure they are solid after drilling.
- ③ Check and make sure that there is no water leakage at the faucet.

Illustrations below are for reference only

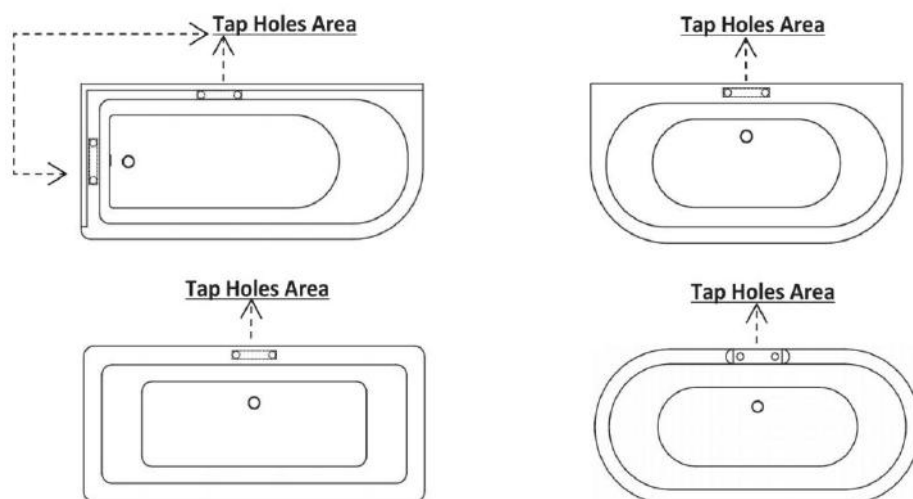

### For more information

- visit [betterbathrooms.com](http://betterbathrooms.com)
- email [customerservices@buyitdirect.co.uk](mailto:customerservices@buyitdirect.co.uk)
- call 0330 390 3062
- write to Trident Business Park, Neptune Way, Huddersfield, HD2 1UA

**better  
bathrooms**

Part of the BuyItDirect Group